

# Jackson

SYSTEMS

## Installation Manual

### Comfort System™ T-32-P Universal Thermostat



For Version 2.19 and 2.20

## INTRODUCTION

**This manual should not be left with the owner as it contains installer setup functions which, if not correctly set, may cause damage to the HVAC equipment or seriously affect performance.**

The T-32-P thermostat is intuitive, reliable and easy to install. Using a common sense approach to the installation will ensure this product is installed properly and to the customer's satisfaction. Please take time to read and understand this manual so that installation and testing is undertaken in an efficient manner.

This manual is to be used in conjunction with the supplied User Manual.

**Although great care has been taken in the preparation of this manual, Jackson Systems takes no responsibility for errors or omissions contained herein. It is the responsibility of the installer to ensure that this thermostat and the equipment connected to it operate in a safe and efficient manner.**

*Due to ongoing product improvements, Jackson Systems reserves the right to change the specifications of the T-32-P thermostat or its components without notice.*

*All rights reserved.*

*© Jackson Systems, LLC 2009.  
Intellectual rights apply.*

*5418 Elmwood Avenue  
Indianapolis, Indiana 46203  
888-652-9663  
www.jacksonsystems.com*

## TABLE OF CONTENTS

Introduction . . . . .	2
Getting started . . . . .	3
Installing the thermostat . . . . .	3
Disassembly . . . . .	3
Thermostat location . . . . .	3
Mounting the subbase . . . . .	3
Terminal designations . . . . .	4
Typical system wiring diagram . . . . .	4
Heat only . . . . .	4
1 heat / 1 cool . . . . .	4
2 heat / 2 cool . . . . .	4
2 heat / 1 cool heat pump . . . . .	5
3 heat / 2 cool heat pump . . . . .	5
2 heat / 1 cool dual fuel . . . . .	5
3 heat / 2 cool dual fuel . . . . .	5
Special instructions for dual fuel applications . . . . .	6
Activating the battery . . . . .	6
Setting the system switches . . . . .	6
System switch functions . . . . .	6
Factory default settings . . . . .	6
Entering the advanced installer settings menu . . . . .	7
Advanced installer settings menu . . . . .	7
TT terminal functions . . . . .	8
Remote sensors . . . . .	8
Outdoor sensor wiring . . . . .	8
Indoor sensor wiring . . . . .	9
Using multiple sensors for temperature averaging . . . . .	9
Remote ON/OFF or override . . . . .	9
Testing . . . . .	9
Testing fan operation . . . . .	10
Testing conventional heating and cooling operation . . . . .	10
Testing heat pump operation . . . . .	10
Resetting the time delays . . . . .	10
Factory Test Mode . . . . .	10
Adaptive Recovery . . . . .	10
Basic trouble shooting . . . . .	10
Remote sensor installation instructions . . . . .	11
Specifications . . . . .	11

## GETTING STARTED

As with any HVAC project, careful installation is the key to a successful outcome. Time taken during the installation process will be rewarded by fewer call-backs.

The steps required to install the T-32-P thermostat are as follows:

1. Read and understand this Installation Manual and User Manual.
2. Mount the T-32-P.
3. Set the 8 system switches to match the equipment application.
4. Wire the optional remote temperature sensor(s) or devices.
5. Power the thermostat.
6. Set the Advanced Installer Setup options.
7. Program and setup the T-32-P thermostat. (Refer to the User Manual for instructions)
8. Test heating, cooling and other functions.

## INSTALLING THE THERMOSTAT

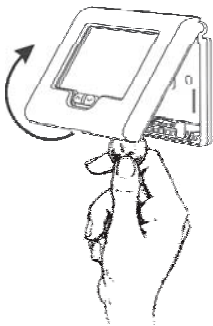

FIGURE 1

### DISASSEMBLY

Insert a small coin (dime) in the release slot located on the bottom of the thermostat. Gently twist the coin to release the thermostat from the subbase. Avoid twisting the case as this may stress the LCD or bend the terminal connector pins. (Figure 1)

## THERMOSTAT LOCATION

The T-32-P should be installed in a location that represents the ambient space temperature. Do not install the thermostat in an area where drafts are present, near the floor, behind doors or on an external wall. Avoid placing the thermostat in areas where the air movement is limited, affected by direct sunlight or other areas not typical of the temperature in the space.

## MOUNTING THE SUBBASE

When mounting the T-32-P, be aware that drafts may travel down wall cavities and enter the back of the thermostat through the control wire hole in the wall. It is important to seal the hole to prevent any drafts that might affect the internal temperature sensor.

Pull the control wires through the large opening in the thermostat subbase then level and mount the subbase on the wall using the supplied anchors and screws.

**Do not over tighten the mounting screws as the subbase may warp causing the improper seating of the thermostat connecting pins to the terminal blocks.**

Use a properly sized screwdriver and land each wire to its dedicated terminal.

**Do not over tighten the terminal screws.**

Check to ensure that all wires are landed correctly and dressed properly to prevent any shorts. (Figure 2)

Refer to Typical System Wiring Diagrams in this manual.

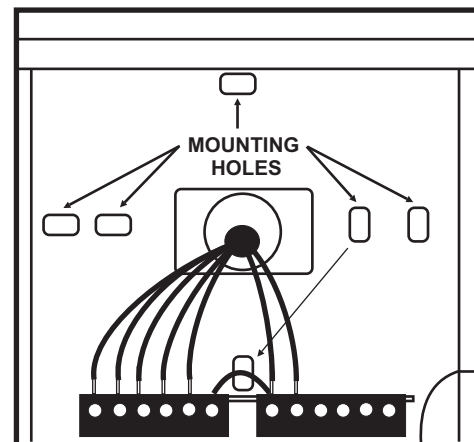

FIGURE 2

## INSTALLING THE THERMOSTAT

### TERMINAL DESIGNATIONS

Based on the T-32-P slide switch configurations, some terminals have multiple output functions. (Figure 3)

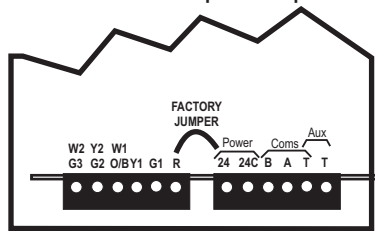
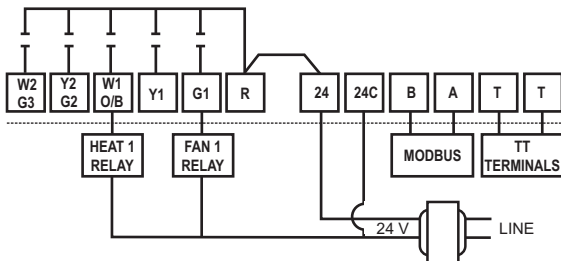

FIGURE 3

TERMINAL DESIGNATION CHART	
TERMINAL	DESIGNATION
W2	Second Stage Heating or Auxiliary Heat
Y2	Second Stage Compressor
W1	First Stage Heating
O/B	Reversing Valve
Y1	First Stage Compressor
G1	Fan Relay
R	24 Volt Hot (Jumpered to '24')
24	24 Volt Hot
24C	24 Volt Common
B	Modbus Communications
A	Modbus Communications
T	Auxiliary Input Terminal
T	Auxiliary Input Terminal

### TYPICAL SYSTEM WIRING DIAGRAMS

#### HEAT ONLY



#### Switch Settings

- Sw1 = OFF (Fan Relay)
- Sw2 = OFF (Heat / Cool)
- Sw3 = OFF (Single Stage)
- Sw4 = OFF (Equipment Controls Fan)
- Sw5 = Installer Preference  
(ON = 4 Minutes Short Cycle Protection)
- Sw6 = User Preference  
(OFF = Non-programmable)  
(ON = Programmable)
- Sw7 = Installer Preference  
(OFF = 2 Minute Run Time)  
(ON = 6 Minute Run Time)
- Sw8 = ON (2 Setpoints)

Set FN=H in Advanced Installer Settings  
(Heat Only)

#### 1 HEAT / 1 COOL

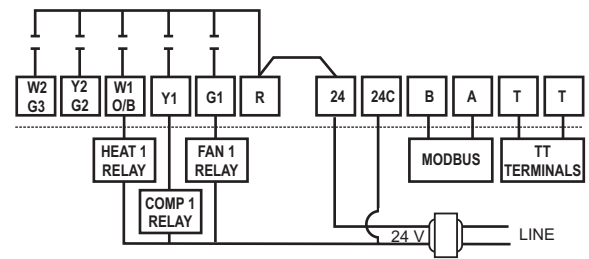

#### Switch Settings

- Sw1 = OFF (Fan Relay)
- Sw2 = OFF (Heat / Cool)
- Sw3 = OFF (Single Stage)
- Sw4 = OFF (Equipment Controls Fan)
- Sw5 = Installer Preference  
(OFF = No Short Cycle Protection)  
(ON = 4 Minute Short Cycle Protection)
- Sw6 = User Preference  
(OFF = Non-programmable)  
(ON = Programmable)
- Sw7 = Installer Preference  
(OFF = 2 Minute Minimum Run Time)  
(ON = 6 Minute Minimum Run Time)
- Sw8 = ON  
(Separate Heating and Cooling Setpoints)

#### 2 HEAT / 2 COOL

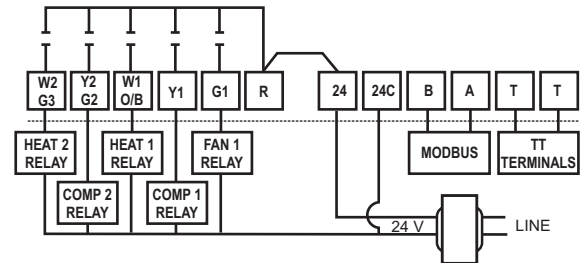

#### Switch Settings

- Sw1 = OFF (Fan Relay)
- Sw2 = OFF (Heat / Cool)
- Sw3 = ON (Two Stage)
- Sw4 = OFF (Equipment Controls Fan)
- Sw5 = Installer Preference  
(OFF = No Short Cycle Protection)  
(ON = 4 Minute Short Cycle Protection)
- Sw6 = User Preference  
(OFF = Non-programmable)  
(ON = Programmable)
- Sw7 = Installer Preference  
(OFF = 2 Minute Minimum Run Time)  
(ON = 6 Minute Minimum Run Time)
- Sw8 = ON  
(Separate Heating and Cooling Setpoints)

## 2 HEAT / 1 COOL HEAT PUMP

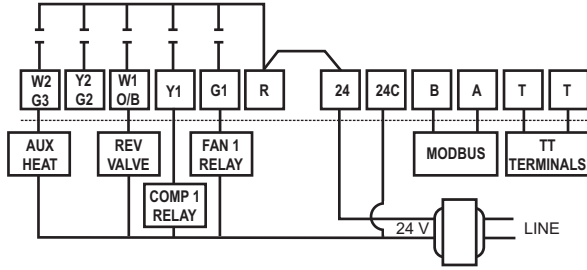

### Switch Settings

- Sw1 = OFF (Fan Relay)
- Sw2 = ON (Heat Pump)
- Sw3 = OFF (Single Stage)
- Sw4 = Reversing Valve  
(OFF = 'O' - RV Energized in Cooling)  
(ON = 'B' - RV Energized in Heating)
- Sw5 = Installer Preference  
(OFF = No Short Cycle Protection)  
(ON = 4 Minute Short Cycle Protection)
- Sw6 = User Preference  
(OFF = Non-programmable)  
(ON = Programmable)
- Sw7 = Installer Preference  
(OFF = 2 Minute Minimum Run Time)  
(ON = 6 Minute Minimum Run Time)
- Sw8 = ON  
(Separate Heating and Cooling Setpoints)

## 3 HEAT / 2 COOL HEAT PUMP

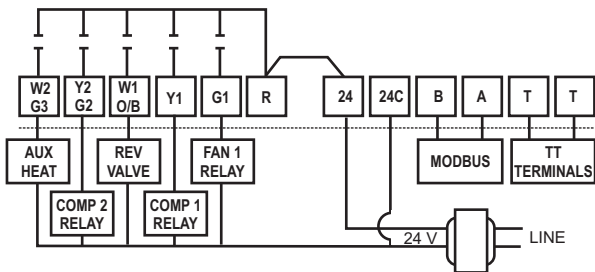

### Switch Settings

- Sw1 = OFF (Fan Relay)
- Sw2 = ON (Heat Pump)
- Sw3 = ON (Two Stage)
- Sw4 = (Reversing Valve)  
(OFF = 'O' - RV Energized in Cooling)  
(ON = 'B' - RV Energized in Heating)
- Sw5 = Installer Preference  
(OFF = No Short Cycle Protection)  
(ON = 4 Minute Short Cycle Protection)
- Sw6 = User Preference  
(OFF = Non-programmable)  
(ON = Programmable)
- Sw7 = Installer Preference  
(Off = 2 Minute Minimum Run Time)  
(ON = 6 Minute Minimum Run Time)
- Sw8 = ON  
(Separate Heating and Cooling Setpoints)

## 2 HEAT / 1 COOL DUAL FUEL

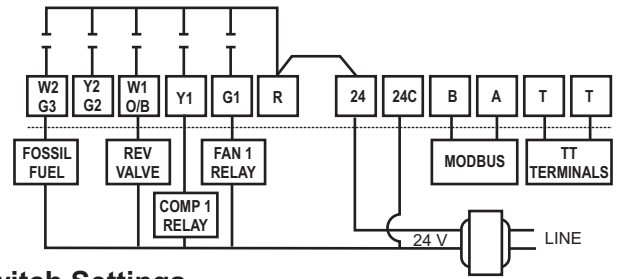

### Switch Settings

- Sw1 = OFF (Fan Relay)
- Sw2 = ON (Heat Pump)
- Sw3 = OFF (Single Stage)
- Sw4 = Reversing Valve  
(OFF = 'O' - RV Energized in Cooling)  
(ON = 'B' - RV Energized in Heating)
- Sw5 = Installer Preference  
(OFF = No Short Cycle Protection)  
(ON = 4 Minute Short Cycle Protection)
- Sw6 = User Preference  
(OFF = Non-programmable)  
(ON = Programmable)
- Sw7 = Installer Preference  
(OFF = 2 Minute Minimum Run Time)  
(ON = 6 Minute Minimum Run Time)
- Sw8 = ON  
(Separate Heating and Cooling Setpoints)

## 3 HEAT / 2 COOL DUAL FUEL

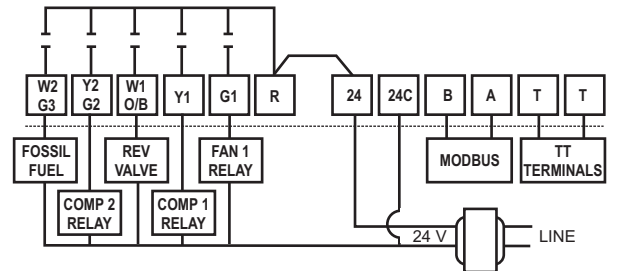

### Switch Settings

- Sw1 = OFF (Fan Relay)
- Sw2 = ON (Heat Pump)
- Sw3 = ON (Two Stage)
- Sw4 = Reversing Valve  
(OFF = 'O' - RV Energized in Cooling)  
(ON = 'B' - RV Energized in Heating)
- Sw5 = Installer Preference  
(OFF = No Short Cycle Protection)  
(ON = 4 Minute Short Cycle Protection)
- Sw6 = User Preference  
(OFF = Non-programmable)  
(ON = Programmable)
- Sw7 = Installer Preference  
(OFF = 2 Minute Minimum Run Time)  
(ON = 6 Minute Minimum Run Time)
- Sw8 = ON  
(Separate Heating and Cooling Setpoints)

## SPECIAL INSTRUCTIONS FOR DUAL FUEL APPLICATIONS

When the T-32-P is used with dual fuel systems, an outdoor sensor is recommended for balance point control (Model T-32-S1). The sensor is wired to the TT terminals on the thermostat. In the **Advanced Installer Settings**, set **TT = OA**. This configures the thermostat to receive the outdoor temperature information. High and low balance point settings are also set in the **Advanced Installer Settings**. **HB = 55** is the factory default high balance point setting and **LB = 35** is the factory default low balance point setting in degrees Fahrenheit. High balance point is adjustable from 32° F to 122° F and low balance point is adjustable from 15° F to 77° F.

**It is very important that the W2 relay be configured to lock out the heat pump on low balance point or whenever the thermostat calls for auxiliary or emergency heat. In the Advanced Installer Settings, set H3 = FF.**

## ACTIVATING THE BATTERY

The T-32-P contains a 3 volt Lithium cell battery that maintains the time of day in the event of a power failure. To activate the battery, carefully remove the white tab. (Figure 4)

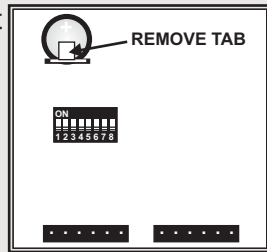

FIGURE 4

## SETTING THE SYSTEM SWITCHES

The T-32-P contains a set of eight system switches located on the thermostat printed circuit board. The switches are used to match the thermostat with the specific type of HVAC system and user preferences. Refer to the system switch functions to properly configure the thermostat. (Figure 5)

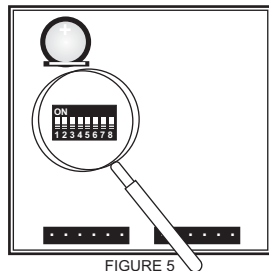

FIGURE 5

## SYSTEM SWITCH FUNCTIONS

<b>Sw1 - Fan Relay</b>	Leave Switch 1 OFF (factory default).
<b>Sw2 - Equipment</b>	Switch 2 sets the equipment configuration. For heat / cool equipment, set the switch to the OFF position (factory default). For heat pump equipment, set the switch to the ON position.
<b>Sw3 - Equipment Stages</b>	Switch 3 sets the equipment stages. For single stage equipment, set the switch to the OFF position (factory default). For multi-stage equipment, set the switch to the ON position.
<b>Sw4 - Fan Mode or Reversing Valve</b>	Switch 4 sets the fan logic for heat / cool systems or sets the reversing valve configuration for heat pump systems.  <b>Fan Mode</b> - For gas or oil systems (equipment controls fan in heating mode), set the switch to the OFF position (factory default). For electric systems (thermostat controls fan in heating mode), set the switch to the ON position.  <b>Reversing Valve</b> - For 'O' reversing valve (energize in cooling), set the switch to the OFF position (factory default). For 'B' reversing valve (energize in heating), set the switch to the ON position.
<b>Sw5 - Short Cycle Timer</b>	Leave switch 5 ON for 4 minute short cycle protection (factory default).
<b>Sw6 - Thermostat Operation</b>	Switch 6 sets the thermostat operation. For programmable, set the switch in the ON position (factory default). For non-programmable, set the switch in the OFF position.
<b>Sw7 - Minimum Run Time</b>	Leave switch 7 to OFF for 2 minute minimum run time (factory default).
<b>Sw8 - Program Schedule</b>	Leave switch 8 to ON for separate heating and cooling setpoints (factory default).

## FACTORY DEFAULT SETTINGS

SWITCH	ON/OFF	FUNCTION
1 - Fan	OFF	Fan Relay
2 - Equipment	OFF	Heat / Cool
3 - Stages	OFF	1 Stage
4 - Fan Mode / Reversing Valve	OFF	Equipment Controls Fan / 'O' Reversing Valve
5 - Short Cycle Timer	ON	4 Minute Short Cycle Protection
6 - Operation	OFF	Manual
7 - Minimum Run Time	OFF	2 Minutes
8 - Setpoints	ON	Leave switch 8 to ON for separate heating and cooling setpoints.

## ENTERING THE ADVANCED INSTALLER SETTINGS MENU

The T-32-P contains factory defaults for all Advanced Installer Settings. Depending upon the user and equipment application, some settings may need to be changed.

To enter the Advanced Installer Settings menu, push the **O/RIDE** button once then hold it down (15 seconds) until the number “**88:15**” is displayed on the LCD. Using the (▲) (▼) arrow button, adjust the value until it reads “**88:32**” and then press the **O/RIDE** button to enter the menu. You can move forward or backwards through the menu by pressing the **O/RIDE** or **PROG** buttons.

## ADVANCED INSTALLER SETTINGS MENU

Symbol	Default	Function
PN <i>Pn</i>	32	Keyboard Lock PIN. This is the required PIN for future entry into the Advanced Installer Setup menu. (Range 00-99)
LC <i>Lc</i>	00	Keyboard Lock OFF
Programmable Mode		LC=01 - All buttons are locked except (▲) (▼) buttons. LC=02 - All buttons are locked except <b>O/RIDE</b> and (▲) (▼) buttons. LC=03 - All buttons are locked except <b>MODE</b> , <b>O/RIDE</b> and (▲) (▼) buttons. LC=04 - All buttons are locked except <b>MODE</b> and (▲) (▼) buttons. LC=05 - All buttons are locked except <b>O/RIDE</b> button. LC=06 - All buttons are locked.
Manual Mode (Sw6=OFF)		LC=00 - Keyboard lock OFF. LC=01 - All buttons are locked except <b>MODE</b> button. LC=02 - All buttons are locked except <b>MODE</b> and (▲) (▼) buttons. LC=03 - <b>FAN</b> , and <b>PROG</b> are locked. <b>MODE</b> button can only select Auto or OFF. LC=04 - <b>MODE</b> button can only select Auto or OFF. LC=05 - All buttons are locked. LC=06 - Same function as LC-05.
HL <i>Hl</i>	90	Maximum Heating or High Temperature Limit. (Adjustable from 41° F - 120° F)
CL <i>Cl</i>	50	Minimum Cooling or Low Temperature Limit. (Adjustable from 43° F - 122° F)
CF <i>Cf</i>	F	Temperature Display (Degrees F or C)
C1 <i>C1</i>	0.0	Internal Sensor Calibration (Adjustable +/- 9° F)
TC <i>Tc</i>	12	Time Format (12 or 24 Hour Clock)
TD <i>Td</i>	0	Temperature Display
		TD=0 - Displays set and space temperatures. TD=1 - Displays only the set temperature.
AH <i>Ah</i>	2.0	After Hours Override Timer
4 Schedules (Sw6=ON) (Sw8=ON)		Temporary Program Override 0 (OFF) extends override to next program change. 1 - 12 equals fixed hours of override.

## ADVANCED INSTALLER SETTINGS MENU

Symbol	Default	Function
ST <i>St</i>	OF	Leave at factory default
SC <i>Sc</i>	OF	Leave at factory default
SH <i>Sh</i>	OF	Leave at factory default
DB <i>db</i>	2	Leave at factory default
FO <i>Fo</i>	0	Advanced Fan Function Fan runs continuously in ON mode.  FO=1 - Fan continues to run after FO=2 - In programmable mode (Sw6=ON), fan runs continuously with program 1 through 4 and then in AUTO from program 4 - 1. FO=3 - In programmable mode (Sw6=ON), fan control is a combination of option 1 and 2.
FP <i>Fp</i>	0	Fan Purge Adjustable from 0 - 5 minutes after heating or cooling cycle.
FN <i>Fn</i>	A	Mode - Heat / Cool system.  FN=C - Cooling only system. FN=H - Heating only system.
H3 <i>H3</i>	AL	H3=AL - W2 relay used for auxiliary and emergency heat. (Sw1 = OFF) (Sw2 = ON)
		H3=EH - W2 relay controls emergency heat. H3=AH - Do not use this function. H3=FF - Fossil Fuel (Y is locked out when W2 is energized). H3 = OF - W2 relay only operates as auxiliary heat in heat pump mode.
TT <i>Tt</i>	RS	For <b>NO</b> remote sensor <b>OR</b> 1 or more remote indoor sensor without the onboard sensor being used.
		TT=OA - For outdoor remote sensor connection. TT=DA - Sends measured temperature from remote sensor via modbus but does not display the value on the LCD. TT=OC - For connecting dry contact switch. (Replaces user setpoints with pre-programmed cooling 'OC' and heating 'OH' setpoints) TT=OF - For connecting dry contact switch. (Turns thermostat off when closed) TT=AV - For averaging <b>BOTH</b> the internal thermostat sensor and remote indoor sensor(s) together.
AF <i>Af</i>	1	Freeze protection ON. If thermostat is OFF, heating will come on if room temperature falls below 41° F.
		AF=0 - No freeze protection.
OH <i>oH</i>	OF	Override Heating Setpoint. (Adjustable from 41° F - 120° F)
OC <i>oC</i>	OF	Override Cooling Setpoint. (Adjustable from 43° F - 122° F)

## ADVANCED INSTALLER SETTINGS MENU

Symbol	Default	Function
SP <i>SP</i>	1	1.4° F differential for stage 1. SP=2 - 1.9° F differential. SP=3 - 2.4° F differential.
SD <i>SD</i>	1	1.4° F differential for stage 2. SP=2 - 1.9° F differential. SP=3 - 2.4° F differential.
S3 <i>S3</i>	1	1.4° F differential for stage 3. S3=2 - 1.9° F differential. S3=3 - 2.4° F differential.
SU <i>SU</i>	10	Leave at factory default.
DT <i>dt</i>	20	Upstage Timer. (Adjustable from 10 - 90 minutes in 5 minute increments) Only works if thermostat has not called for 2nd or 3rd stage. (Sw3=ON)
OS <i>oS</i>	1	Adaptive Recovery ON. OS=0 = Adaptive Recovery OFF.
C2 <i>C2</i>	0.0	Remote sensor calibration. (Adjustable +/- 9° F)
CO <i>Co</i>	55	Cooling OFF temperature. Only works if TT=OA with outdoor sensor. When outdoor temperature falls below setpoint, cooling will shut off. (Adjustable from 41° F - 122°F)
HO <i>Ho</i>	75	Heating OFF temperature. Only works if TT=OA with outdoor sensor. When outdoor temperature rises above setpoint, heating will shut off. (Adjustable from 41° F - 122° F)
HB <i>HB</i>	55	High Balance Point. Only works if TT=OA with outdoor sensor and H3=FF for fossil fuel. W2 auxiliary heat is locked out when temperature rises above HB setpoint. (Adjustable from 32° F - 122° F)
LB <i>LB</i>	35	Low Balance Point. Only works if TT=OA with outdoor sensor and H3=FF for fossil fuel. W2 auxiliary heat is locked out when temperature falls below LB setpoint. (Adjustable from 15° F - 77° F)
FT <i>Ft</i>	OF	Replace or clean filter. (Off to 900 hours in 100 hour increments)
AD <i>Ad</i>	1	Modbus Address. (Adjustable from 0 to 32)
BD <i>bd</i>	19.2	Baud Rate. BD=4.8 BD=9.6
CD <i>Cd</i>	0	Commissioning Mode OFF. (All time delays active)
		CD=1- Commissioning Mode ON. (All time delays inactive)

## ADVANCED INSTALLER SETTINGS MENU

Symbol	Default	Function
SS <i>SS</i>	0	Start/Stop Mode. (Controlled by thermostat program) SS=1 - Thermostat in Start only mode per call by Modbus Master. SS=2 - Thermostat in Stop only mode per call by Modbus Master.
OF <i>OF</i>	0	Leave at factory default
RS <i>rS</i>	50	Response Time. (Leave at factory default)
TS <i>tS</i>	0	Factory Test Mode OFF. TS=1 - Display configuration code. TS=2 - Step cycle all relays in sequence. TS=3 - Reset software to factory defaults. (Press fan button to initiate)

## TT TERMINAL FUNCTIONS

The 'T' and 'T' terminals on the T-32-P are primarily used for wiring either an indoor or an outdoor remote sensor. The terminals are not polarity dependent. The terminals can also be used for other functions such as remote ON/OFF switching of various control functions depending upon thermostat configuration. Each configuration requires setup in the Advanced Installer menu.

## REMOTE SENSORS

There are two type of remote sensors. The T-32-S1 is a single sensor that can be used indoors or outdoors. The T-32-S2 contains two sensors. A combination of both sensors can be used for indoor temperature averaging to simplify wiring.

## OUTDOOR SENSOR WIRING

When the T-32-S1 is used as an outdoor sensor, the T-32-P will display the outside air temperature. In the Advanced Installer menu, TT=OA. The outdoor sensor can also be used for high and low balance point control in dual fuel systems. Use separate 18-2 thermostat cable when wiring the sensor to the thermostat. If the outdoor sensor fails, or is not wired properly, two dashes will appear on the LCD where the outside temperature would normally be displayed. (Figure 6)

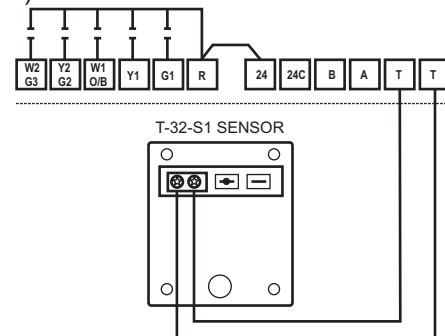

FIGURE 6



**INDOOR SENSOR WIRING**

When the T-32-S1 is used as an indoor sensor, the T-32-P can be configured to allow only the remote sensor to control the temperature (TT=RS) or both the remote and onboard sensor can be used for temperature averaging (TT=AV). An optional in-line switch can also be used with the remote sensor to change the temperature sensing location from remote to onboard sensor. The Advanced Installer menu setting must be TT=RS to use this feature. (Figure 7)

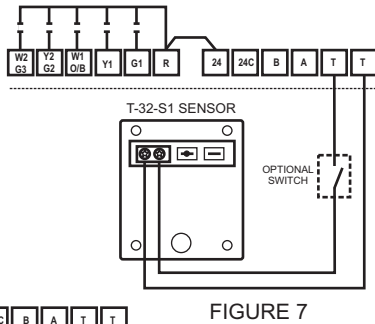

FIGURE 7

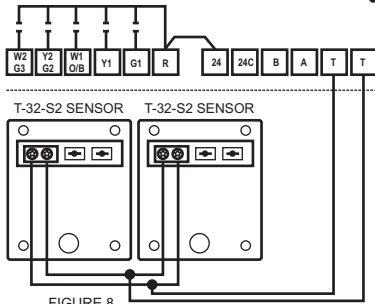

FIGURE 8

**USING MULTIPLE SENSORS FOR TEMPERATURE AVERAGING**

Multiple sensors can be connected to the 'T' and 'T' terminals if temperature averaging is required with or without the use of the thermostat onboard sensor. The total value of remote sensors wired in series/parallel must equal 10kΩ @ 77 F.

The onboard sensor is not part of the equation.

Figure 8 shows (2) T-32-S2 sensors used for

For three sensors, (1) T-32-S2 and (2) T-32-S1 sensors can be wired in series / parallel. For four sensors, (4) T-32-S1 sensors can be wired in series / parallel. Both of these configurations can be used with or without the thermostat onboard sensor. To include the onboard sensor, TT=AV. To exclude the onboard sensor, TT=RS.

**REMOTE ON/OFF OR OVERRIDE**

Using an external dry contact switch, the T-32-P can be configured to turn the thermostat off or change the heating and cooling setpoints to a pre-programmed override value. (Figure 9)

To turn the thermostat off, TT=OF in the Advanced Installer menu. When the switch is closed, the T-32-P will turn off and the word **OFF** will flash on the LCD. When the switch is opened, the thermostat will return to the user settings.

For remote override, TT=OC in the Advanced Installer menu. Override setpoints are programmed in the Advanced Installer menu using 'OC' (Cooling setpoint) and 'OH' (Heating setpoint). When the switch is closed, the user setpoints are replaced by the pre-programmed override setpoints. When the switch is open, the thermostat will return to the user settings.

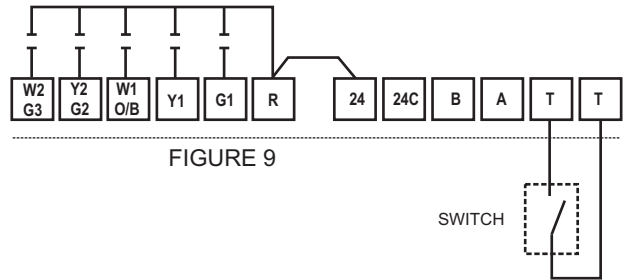
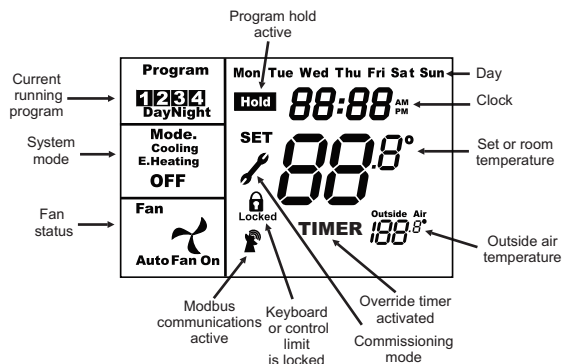

FIGURE 9

**TESTING**

Testing ensures that the thermostat and the HVAC equipment operate properly. Follow the detailed testing steps and refer to the Troubleshooting Guide in this manual if any problems are encountered.

When the T-32-P is powered, the LCD will briefly show all available LCD icons, software version, then display the time and operating mode, etc.



The T-32-P incorporates a number of time delays which can be disabled during testing by setting CD=1 in the Advanced Installer menu. After exiting the menu, a wrench icon will flash on the LCD. This is to remind you that once testing is completed, the time delays need to be re-initiated by setting CD=0 in the Advanced Installer menu.

### TESTING FAN OPERATION

Press the **MODE** button until the word **OFF** is displayed on the LCD. Press the **FAN** button and the word **Fan On** will appear. After a brief moment, the internal fan relay will energize and the fan icon will appear and rotate.

### TESTING CONVENTIONAL HEATING AND COOLING OPERATION

Press the **MODE** button until Mode **Heat** appears on the LCD. Use the (▲) button and raise the setpoint a few degrees above the space temperature. The heating relay will energize and the word **Heat** will change to **Heating**. If the thermostat has been configured for multi-stage operation, raise the setpoint further and the second stage heating relay will energize. A period ( . ) will be displayed after the word **Mode**.

Press the **MODE** button until Mode **Cool** appears on the LCD. Use the (▼) button and lower the setpoint a few degrees below the space temperature. The cooling and fan relays will energize and the word **Cool** will change to **Cooling**. If the thermostat has been configured for multi-stage operation, lower the setpoint further and the second stage cooling relay will energize. A period ( . ) will be displayed after the word **Mode**.

### TESTING HEAT PUMP OPERATION

When the T-32-P is configured for heat pump operation, testing is the same as for a conventional heating and cooling system with the exception that the fan relay is energized on a call for both heating and cooling. **Emergency Heat mode is only active when the thermostat is set to H3=EH, H3=FF or H3=AL in the Advanced Installer menu.** When the thermostat is placed in the emergency heat mode, **E. Heat** will be displayed on the LCD. When the W2 relay is energized **E. Heating** will be displayed on the LCD.

When the thermostat is in the heat pump mode, the reversing valve is energized with a cooling call 'O' or heating call 'B' and remains energized until there is an opposite call or if after 30 minutes there is no call, the reversing valve will de-energize.

### RESETTING THE TIME DELAYS

After testing the thermostat, change CD=1 to CD=0 in the Advanced Installer menu. This will be confirmed when the flashing wrench icon no longer appears on the LCD.

### FACTORY TEST MODE

The T-32-P contains a simple factory Test Mode that can confirm relay outputs, slide switch configuration along with a factory default reset.

TS=0 - Factory Test Mode is OFF

TS=1 - Displays system configuration code based on slide switch settings, (for factory use only).

TS=2 - Cycles each relay on and off in an endless loop. **Equipment should be disabled when performing this test.**

TS=3 - Reset software to factory defaults. Press **Fan** button to initiate.

### ADAPTIVE RECOVERY

Adaptive Recovery is only available in programmable mode (Sw6=ON and OS=1). The Adaptive Recovery function of the T-32-P permits the user to program a time that a desired set temperature is required. The thermostat then calculates the most energy efficient time to bring on the equipment to reach the setpoint at the designated time. This calculation involves a complex control algorithm that compares the space temperature distance from setpoint, and rate of recovery history. "RECO" flashes on the LCD when Adaptive Recovery is active.

### BASIC TROUBLE SHOOTING

SYMPTOM	POSSIBLE FAULT AND REMEDY
No LCD Display	Remove thermostat from subbase and check for 24 volts across '24' and '24C'. Make sure factory jumper is between 'R' and '24'. If no voltage, check voltage on HVAC for 24 volts at HVAC system terminals 'R' and 'C'. If no voltage, fault is equipment related. If voltage, fault could be in wiring.
"Locked" appears on the LCD and Heating or Cooling will not operate.	This is not a fault. If an outdoor sensor is being used, it could be preventing heating or cooling calls based on the outdoor air temperature either being about or below the HO and CO value which may require changing in the Advanced Installer menu.
Temperature display inaccurate.	Air from the wall cavity may be leaking into the rear of the thermostat. Seal holes in the wall to prevent air infiltration. The temperature sensor might be folded back inside the thermostat and is not being exposed to the room temperature. Carefully move the sensor head so that it is just behind the sensor opening in the case. External influence from appliances, lighting or drafts may be affecting temperature accuracy. Move lamps or other sources of abnormal temperature influence away from the thermostat.

## BASIC TROUBLE SHOOTING

SYMPTOM	POSSIBLE FAULT AND REMEDY
Wrench icon flashes on LCD	This is not a fault. Commissioning mode is enabled and time delays are overridden. Change CD=1 to CD=0 in the Advanced
Outdoor temperature does not display. Dashes (---) appear on the LCD.	Check wiring to outdoor sensor. Make sure that TT=OA in the Advanced Installer menu.
Heating or Cooling is flashing while the HVAC system is running.	This is not a fault. The T-32-P has a built-in minimum equipment run time of either 2 or 6 minutes. Sw6 may set for 6 minutes (ON) which is keeping the equipment on after the thermostat reaches setpoint. Try setting
Lock icon flashes when trying to set a higher heating or lower cooling temperature.	This is not a fault. HL and CL restrict the heating and cooling setpoints. The limit values can be changed in the Advanced Installer menu.
Thermostat displays wrong temperature.	The T-32-P can display in either Fahrenheit or Celsius. Change CF=C or F in the Advanced Installer menu.
The fan continues to run after a heating or cooling call is satisfied.	The thermostat is set to Fan ON. Set the thermostat to Auto Fan. The fan purge mode is set to run the fan for a fixed period of time after the equipment shuts off. Change the FP value in the Advanced Installer menu.
Some buttons on the thermostat do not function.	Lock values have been set. Refer to LC settings in the Advance Installer menu.
Thermostat clock does not keep proper time.	Make sure that the plastic tab on the internal fitted battery is removed so that the battery is operational.

## REMOTE SENSOR INSTALLATION INSTRUCTIONS

The T-32-P can use an indoor remote sensor or multiple sensors for temperature averaging or as an outdoor sensor for temperature display or a control function depending upon the thermostat configuration.

## INDOOR SENSOR INSTALLATION

Locate the sensor in the same manner as a thermostat. Mount the sensor 18" away from any outside wall. Do not install the sensor behind doors, in corners or other dead air spaces. Keep the sensor away from direct air flow, supply registers or near sources of heat such as lamps and appliances. The maximum wire length from the sensor to the thermostat is 300 feet. Use a separate 18-2 thermostat cable for sensor wiring. Prior to wiring the sensor to the thermostat, use an ohm-meter or multimeter to measure the resistance of the sensor. Measure at the end of the wires that will connect to the thermostat.

Confirm the resistance value (within 5%) to the temperature where the sensor is mounted. Disconnect power to the thermostat when wiring the sensor to the 'T' and 'T' terminals. Strip only as much insulation off of the wires as necessary to provide a good contact with the terminals. The sensor is not polarity specific so either sensor lead may be connected to either terminal on the

## OUTDOOR SENSOR INSTALLATION

Mount the sensor on a vertical exterior surface below an overhang. Choose a location protected from direct sunlight and exposure to excessive moisture. Follow the same wiring and test procedures as installing an indoor sensor.

## SENSOR CALIBRATION CHART

Temperature (°F)	Resistance (kΩ)	Temperature (°F)	Resistance (kΩ)
30	34.6	70	11.9
40	26.1	80	9.4
50	19.9	90	7.4
60	15.3	100	5.9

## SPECIFICATIONS

Input Voltage	24 VAC 50/60 Hz
Relay Rating	24 VAC @ 1Amp maximum per relay
Operating Temperature	32° F to 122° F
Operating RH	0-95% (non-condensing)
Storage Temperature	32° F to 105° F
Size	4-7/16" W x 4-1/16" H x 7/8" D
LCD Display Size	2-3/4" W x 1-7/8" H
Temperature Sensor	10K NTC type 2
Voltage	20-30 VAC
Resistance	10kΩ @ 77° F
Tolerance	+/- 3% @ 77° F
Stage Delays	Minimum temperature change over time
Timed Upstage Delay	5 - 90 minutes
Short-cycle Delay	Off to 4 minutes
Display Resolution	0.1° F
Control Range	Off to 105° F
Outdoor Air Temperature Range	-10° F to 140° F
Back Light	Blue EL (Electro Luminescent)
Optimized Start/Stop Method	Time to start vs. temperature differential
Communications Protocol	Modbus
Approvals	FCC (Part 15) (Pending)
Warranty	5 years

The T-32-P can be configured for 3-speed fan and single setpoint control.

For information regarding these features, contact Jackson Systems at 1-888-652-9663